

### Hauptmenü Main menu

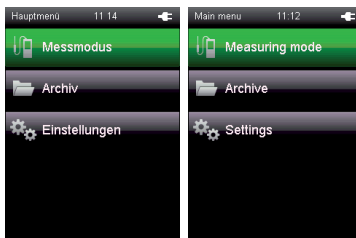

- Messmodus: Messungen durchführen (mit angeschlossenem Fühler oder integriertem Luftdrucksensor)
- Archiv: Archivierte Messwerte aufrufen
- Einstellungen: Geräteeinstellungen vornehmen
  
- Measuring mode: Carry out measurements (with connected probe or integrated air pressure sensor)*
- Archive: Open archived measurements*
- Settings: Change device settings*

### Messmodus Measuring mode

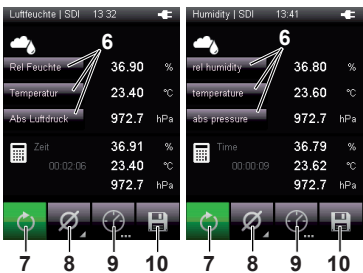

- 6 Auswahl der jeweiligen Messgröße
- 7 Messperiode für MIN, MAX, AVG bzw. HOLD zurücksetzen
- 8 Darstellung der Messwerte festlegen:
  - Minimum: Kleinsten ermittelten Messwert einer Messperiode anzeigen
  - Maximum: Größten ermittelten Messwert einer Messperiode anzeigen
  - Durchschnitt: Durchschnittswert aller ermittelten Messwerte einer Messperiode anzeigen

- Halten: (HOLD) Aktuell ermittelten Messwert halten und dauerhaft anzeigen
- Aus: Anzeige der Messwerte ausschalten
  
- 9 Für die Dauer eines zuvor bestimmten Aufzeichnungsintervalls eine automatische Messung durchführen
- 10 Aktuell angezeigten Messwert als Einzelmessung mit Zeitstempel und Datum im Archiv speichern.
  
- 6 Selection of the respective measured value
- 7 Reset of measuring period for MIN, MAX, AVG or HOLD
- 8 Specification of how measured values are displayed:
  - Minimum: Display smallest measured value from a measuring period
  - Maximum: Display largest measured value from a measuring period
  - Average: Display of the average value of all measured values from a measuring period

- Hold: Hold and continuously display the current measured value (HOLD)
- Off: Switch-off of the display of measured values
  
- 9 Perform automatic measurement for the duration of a previously specified recording interval
- 10 Save currently displayed measured value as single measurement in the archive with date and time stamp.

### Micro-USB-Kabel verbinden Micro-USB cable connection

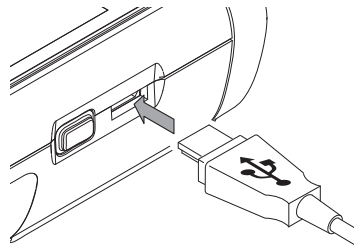

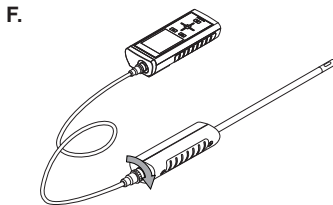
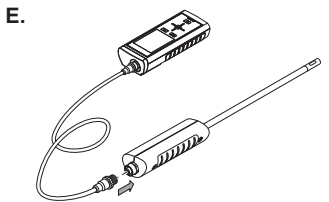
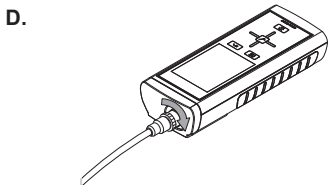
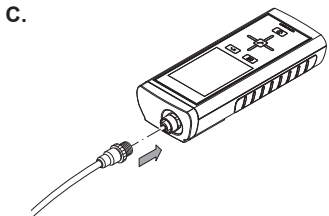
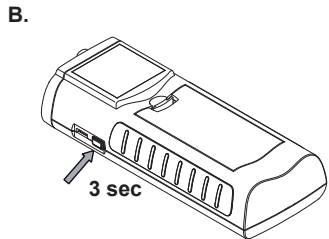
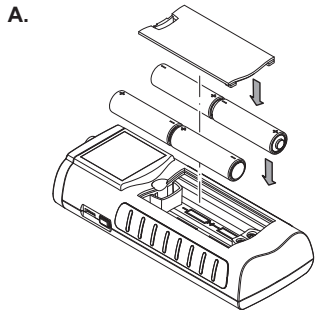

**Bedienungsanleitung:**



[www.epluse.com/omniport30\\_manual\\_de.pdf](http://www.epluse.com/omniport30_manual_de.pdf)

**Bedienelemente**  
**Operating elements**

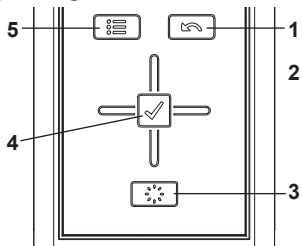

1 Zurück 2 Steuerkreuz  
3 Beleuchtung ein/aus 4 OK 5 Hauptmenü

1 back 2 control cross  
3 illumination on/off 4 OK 5 main menu

**Manual:**



[www.epluse.com/omniport30\\_manual\\_en.pdf](http://www.epluse.com/omniport30_manual_en.pdf)

**PC-Software SmartGraph3:**  
[www.epluse.com/smartgraph3](http://www.epluse.com/smartgraph3)

